

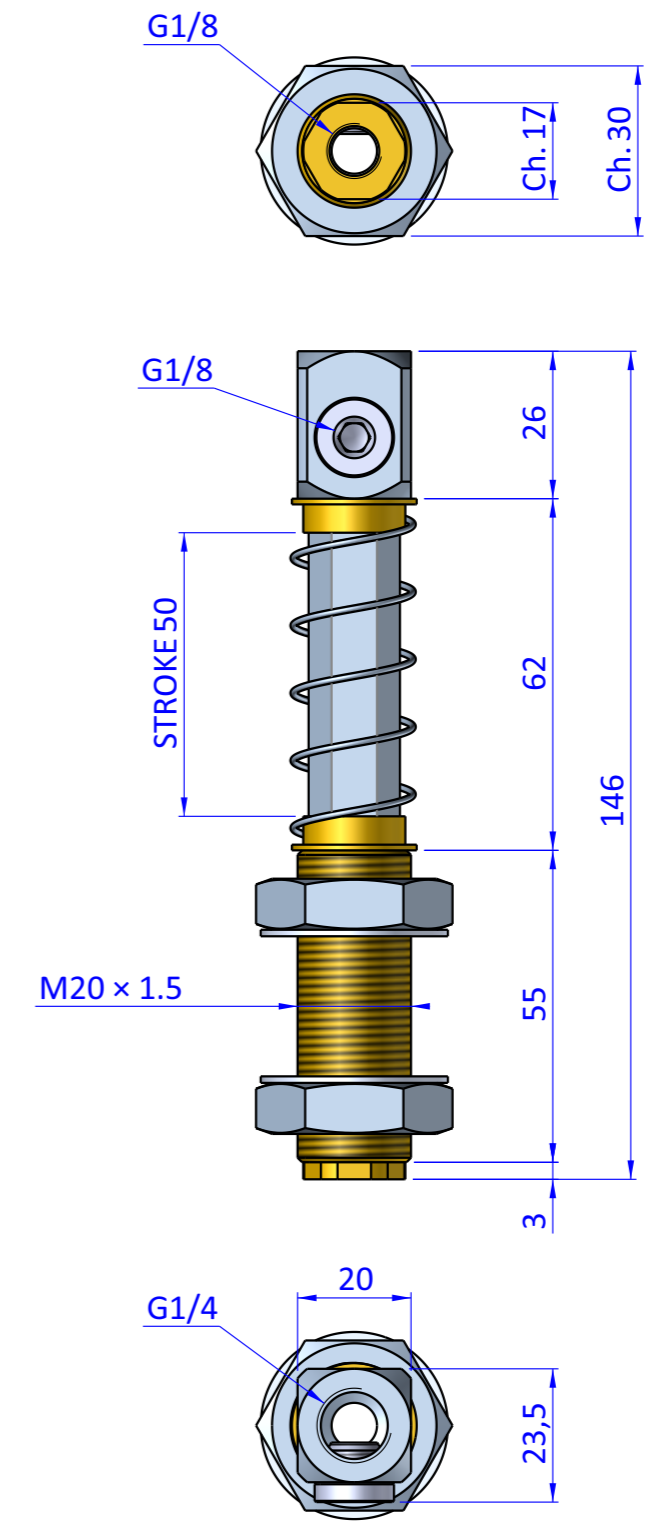

THE PROPERTY OF THE DRAWING IS ESTABLISHED BY LAW. IT IS FORBIDDEN TO PRODUCE OR SHOW IT TO THIRD PART. WITHOUT A WRITTEN AGREEMENT.

Item	Name	Q.ty
1	05.02.001.06	2
2	CA.08.14.014	1
3	M.21x69	1
4	R.20.SCH	2
5	SAE.20141825.1	1
6	SAE.20141825.4	2
7	SAE.20141825.5	1
8	SAE.20141850.1	1
9	SAEG.20141825.3	1

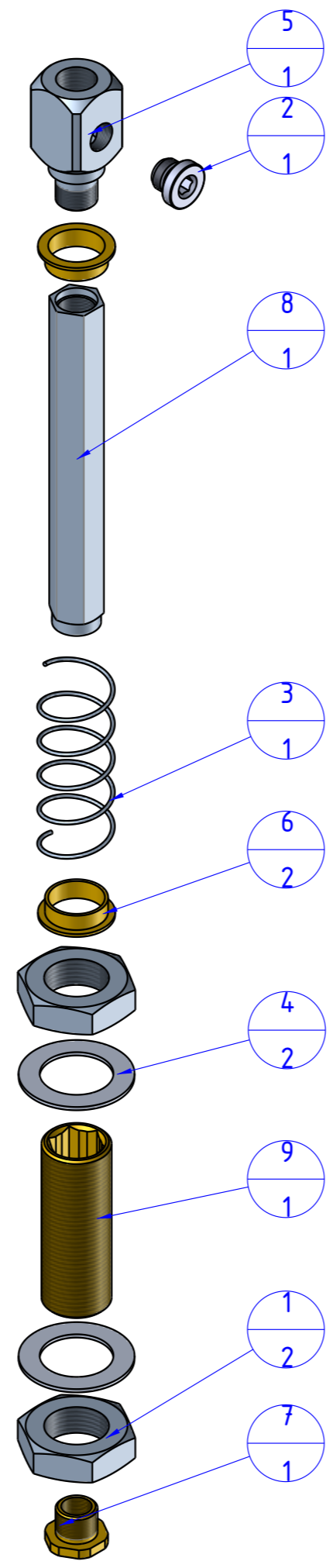

Format A3  
UNI 936-76

 <b>FPS</b> FPSERVICES AUTOMATION		DESIGNED FROM		REVIEW
		FPS Automation		A
GENERAL TOLERANCE		DATE		WEIGHT
UNI - ISO 2768		29/11/2021		0,179kg
CLASSE f		CODE		
		CA.SAEG.20141825		CA.SAEG.20141850